



# SOSEN LED Driver, Your Smart Choice

## Specifications

### SS-240VB Series LED Driver

Model: SS-240VB-XXX

Description: 240W LED Driver

Rev.: V01

Release Date: 2019-07-13

# SS-240VB Series LED Driver

**SOSEN**  
LED DRIVER



LED DRIVER

VB Series



## Features:

- Efficiency up to 94%
- Isolated dimming:0-10V,PWM,Resistor
- Computer programmable
- SSA,CLO,ELA
- IP67
- Protections: SCP/OTP/OVP/OPP
- Comply with the Class P
- TYPE HL, suitable for hazardous locations
- Surge protection: L/N-PE: 10kV, L-N: 6kV
- Warranty: 5 years



**IP67 RoHS Class P**

LISTED  
E360758

## Description :

SS-240VB is a rectangular driver with 90-305Vac input, the 240W model are designed for street and area lights with IP67 and 10kV/6kV surge protection. It has UL listed mark with Class P and Type HL rated.

## Model List:

Model	AC Input Range	Max. Pout	Vout Range	Full Power Vo Range	Iout	THD(Typ.)	PF(Typ.)	Eff.(Typ.)	Max.Tc
SS-240VB-228B	90-305Vac	240W	114-228V	160-218V	0.35-1.5A	8%	0.98	93%	90°C
SS-240VB-343B	90-305Vac	240W	171-343V	228-343V	0.1-1.05A	8%	0.98	94%	90°C

1.Default tested at 220Vac, full load, Ta 25°C.

# SS-240VB Series LED Driver

## Input Characteristics:

Parameter	Min.	Typ.	Max.	Remark
Rated AC Input Range	100Vac		277Vac	
AC Input Range	90Vac		305Vac	
Input Frequency Range	47Hz	50/60Hz	63Hz	
Max Input Current			2.8A	100Vac, Full load
Max Input Power			272W	100Vac, Full load
Max Input Current(120Vac)			60A	Cold start
Max Input Current(220Vac)			135A	Cold start
Max Input Current(277Vac)			175A	Cold start
No Load Power			5W	220Vac/50Hz, No load
Power Factor	0.97	0.98		220Vac/50Hz, Full load
	0.90			100-277Vac/50Hz, 70-100% load
THD		8%	10%	220Vac/50Hz, Full load
			20%	100-277Vac/50Hz, 70-100% load

# SS-240VB Series LED Driver

## Output Characteristics(SS-240VB-228B):

Parameter	Min.	Typ.	Max.	Remark
Output Voltage Range	114V		228V	Power derated @114-160V
Rated Output Voltage	160V		218V	$P_o=V_o \cdot I_o=240W$ , Full load
Rated Output Current	1.1A		1.5A	1.5A for 160V, 1.1A for 218V
Current Adjustable Range(AOC)	0.35A		1.5A	AOC by programming
No Load Voltage			250V	
Efficiency @120Vac	89.0%	90.5%		Output 160V/1.5A
Efficiency @220Vac	92.0%	93.0%		Output 160V/1.5A
Efficiency @277Vac	92.0%	93.0%		Output 160V/1.5A
Output Current Tolerance	-5%		+5%	
Output Current Ripple(PK-AV)		5%	13%	
Start-up Current Overshoot			15%	Full load
Start-up Time			0.5S	120Vac
			0.5S	220Vac
Line Regulation	-2%		+2%	Full load
Load Regulation	-2%		+2%	
Temperature Coefficient	-0.03%/°C		+0.03%/°C	Tc:0°C~90°C
OTP	90°C	100°C	110°C	Tc, Decreases output current, returning to normal after over temperature is removed.
Short Circuit Protection			10W	Driver will not be damaged, Hiccup mode

# SS-240VB Series LED Driver

## Output Characteristics(SS-240VB-343B):

Parameter	Min.	Typ.	Max.	Remark
Output Voltage Range	171V		343V	Power derated @171-228V
Rated Output Voltage	228V		343V	$P_o=V_o \cdot I_o=240W$ , Full load
Rated Output Current	0.7A		1.05A	1.05A for 228V,0.7A for 343V
Current Adjustable Range(AOC)	0.1A		1.05A	AOC by programming
No Load Voltage			360V	
Efficiency @120Vac	89.5%	91.5%		Output 343V/0.7A
Efficiency @220Vac	93.0%	94.0%		Output 343V/0.7A
Efficiency @277Vac	93.0%	94.5%		Output 343V/0.7A
Output Current Tolerance	-5%		+5%	
Output Current Ripple(PK-AV)		5%	13%	
Start-up Current Overshoot			15%	Full load
Start-up Time			0.5S	120Vac
			0.5S	220Vac
Line Regulation	-2%		+2%	Full load
Load Regulation	-2%		+2%	
Temperature Coefficient	-0.03%/°C		+0.03%/°C	Tc:0°C~90°C
OTP	90°C	100°C	110°C	Tc, Decreases output current, returning to normal after over temperature is removed.
Short Circuit Protection			10W	Driver will not be damaged, Hiccup mode

# SS-240VB Series LED Driver

## Other Characteristics:

Parameter	Min.	Typ.	Max.	Remark	
1-10V Dimming (Optional)	Dim Vmax	0V		12V	
	Dim Range	10%Iomax		100%Ioset	
	Rec.Dim Range	1V		10V	
PWM Dimming (Optional)	PWM High	9.8V		10.2V	
	PWM Low	0V		0.3V	
	Frequency	1KHz		2KHz	
	PWM Duty	10%		100%	
Resistor Dimming (Optional)	Resistance	10Kohm		90Kohm	Reference dimming curve
	Dim Range	10%Iomax		100%Ioset	
Lifetime(Tc≤72°C)	≥62,000 hours			80% load	
MTBF	164,000 hours			220Vac, Full load, Ta=25°C (MIL-HDBK-217F)	
IP Grade	IP67				
Tc	90°C				
Warranty	5 years			Refer to life time drawing	
Net Weight	1200g				
Dimension	244mm*71mm*39.6mm			L x W x H	

NOTE: All the parameters above are tested Ta 25°C, unless specified.

# SS-240VB Series LED Driver

## Environmental Requirements

Parameter	Min.	Typ.	Max.	Remark
Operating Temperature(Tcase)	-40°C	25°C	+90°C	
Storage Temperature	-40°C	25°C	+85°C	
Operation Humidity	10%RH		90%RH	
Storage Humidity	5%RH		95%RH	
Altitude	-65m		4000m	

## Safety and EMI/EMS Standards

Certification	Standard	Status	Remark
UL/cUL	UL8750	✓	
ENEC	IEC 61347-2-13:2014/AMD1:2016 used in conjunction with IEC 61347-1:2015	✓	
RCM	AS/NZS61347.2.13		
CCC	GB 19510.14-2009	✓	
CE	EN 61347-2-13:2014 EN61347-1:2008+A1:2011+A2:2013	✓	

EMI/EMS	Criterion	Remark
Conduction Emission	EN55015:2013+A1:2015	
Radiation Emission	EN55015:2013+A1:2015	
Harmonic Current Emissions	IEC/EN 61000-3-2	Class C
Surge	IEC/EN61000-4-5	Difference mode 6kV, Common mode 10kV,Criterion B
Ring Wave	IEC/EN 61000-4-12	Difference mode 6kV, Common mode 6kV,Criterion B

# SS-240VB Series LED Driver

## Safety Test Items:

Safety test items	Technical Indicators			Remark
Insulation Requirements	UL Insulation Requirements	TUV Insulation Requirements	CCC Insulation Requirements	
Input-Output	1600Vac	3000Vac	3750Vac	Reinforced insulation
Input-Case	1600Vac	1500Vac	1875Vac	Basic insulation
Input-Dim	1600Vac	3000Vac	3750Vac	Reinforced insulation
Input-Dim	1600Vac	1000Vac	1000Vac	Additional insulation
Output-Case	1600Vac	1000Vac	1000Vac	Function insulation
Dim-Case	1600Vac	250Vac	250Vac	
Insulation Resistance	≥10MΩ			Input-Output, Test voltage:500Vdc
Ground Resistance	≤0.1Ω			25A/1min
Leak Current	≤0.75mA			277Vac

### NOTE:

1. SOSEN warrants the LED Driver itself meets with EMC standard. However, LED Driver's EMC should be re-checked when integrated into lighting systems due to unexpected interference as component.
2. Please short Line and Neutral, LED+ and LED-, Dim+ and Dim - when Hi-pot test.
3. The CCC withstand voltage test needs to disconnect the built-in lightning protection tube. According to the IEC 60598-1:14 standard section 10.2, the "built-in lightning protection tube" can be marked on the nameplate to disconnect the discharge tube on testing.

## Performance Curves:

### Input Inrush Current

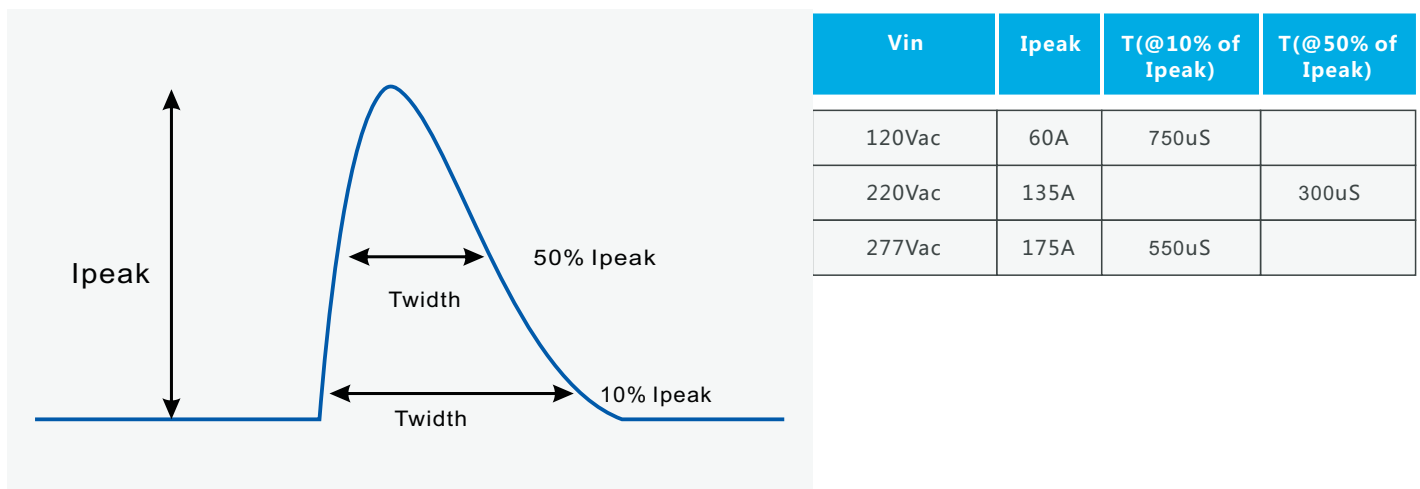



# SS-240VB Series LED Driver

## Performance Curves:

Output Voltage Vs. Output Current(Dim/AOC Window)

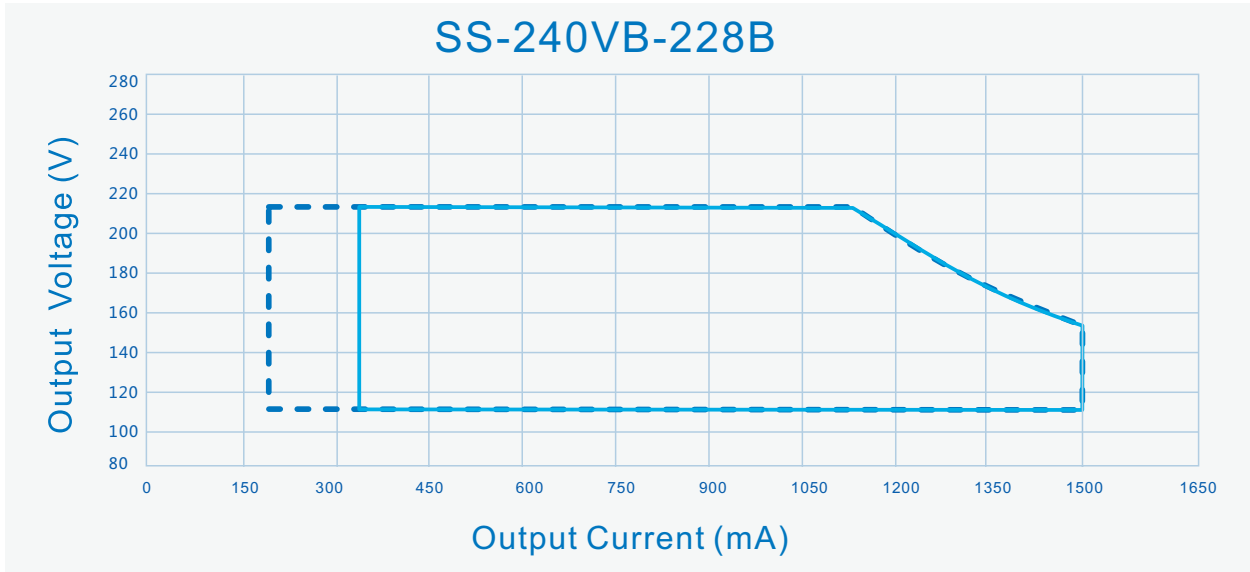

----- Dimming Window

————— AOC Window

Output Voltage Vs. Output Current(Dim/AOC Window)

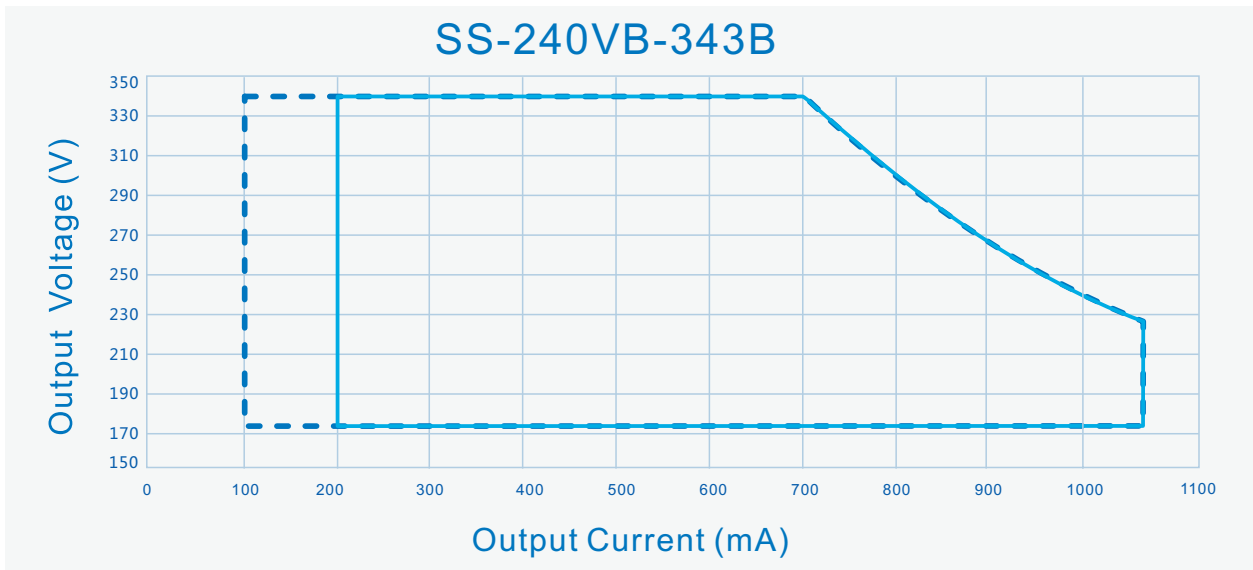

----- Dimming Window

————— AOC Window

# SS-240VB Series LED Driver

## Performance Curves:

Efficiency Vs. Output Voltage ( $V_{in}=120V_{ac}$ )

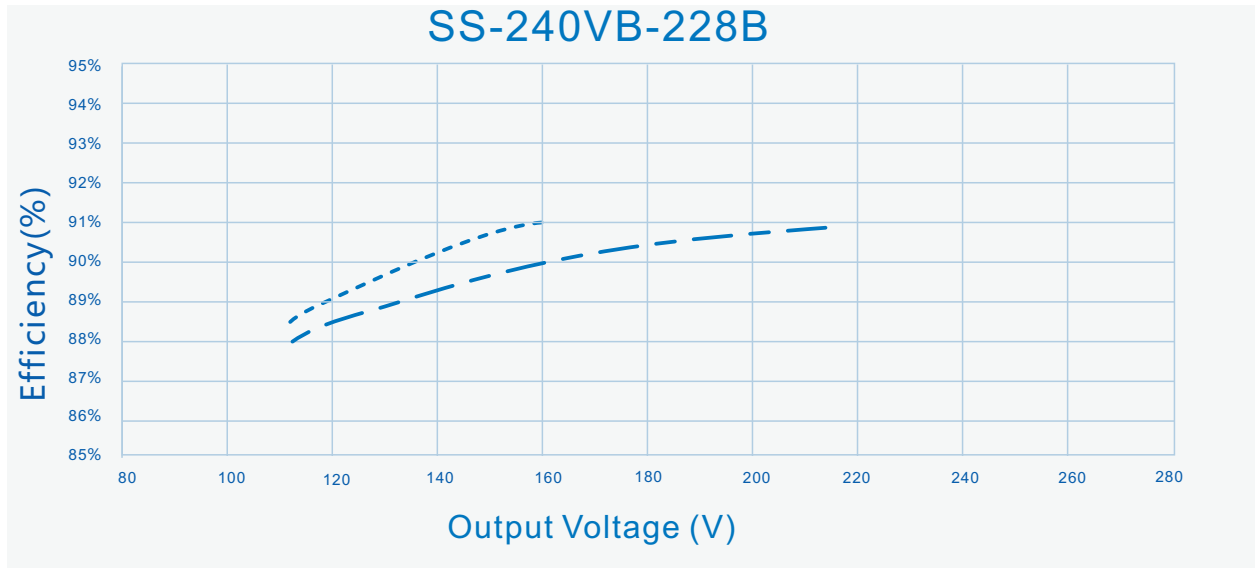

-----  $I_o=1500mA$

- . - .  $I_o=1100mA$

Efficiency Vs. Output Voltage ( $V_{in}=220V_{ac}$ )

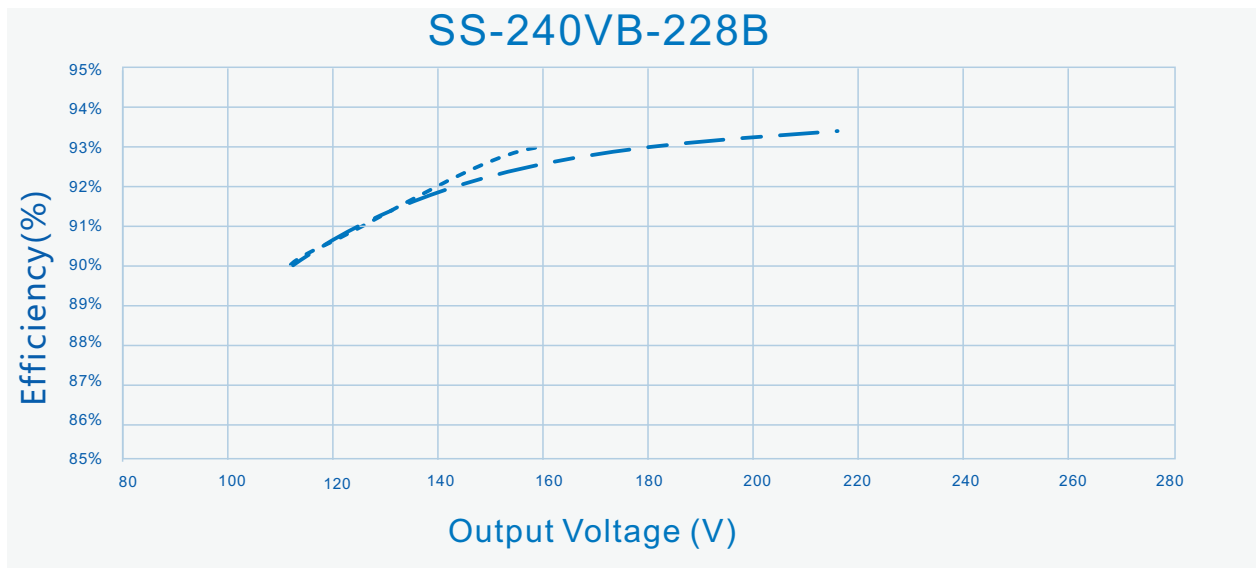

-----  $I_o=1500mA$

- . - .  $I_o=1100mA$

# SS-240VB Series LED Driver

## Performance Curves:

Efficiency Vs. Output Voltage ( $V_{in}=277V_{ac}$ )

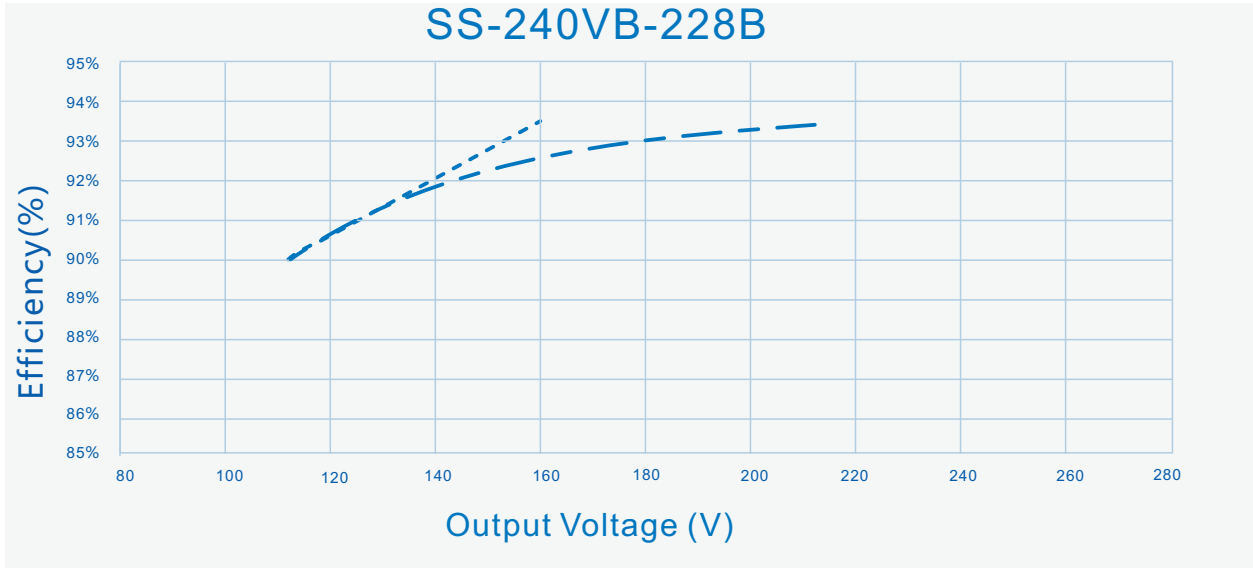

-----  $I_o=1500mA$

- . - . -  $I_o=1100mA$

Efficiency Vs. Output Voltage ( $V_{in}=120V_{ac}$ )

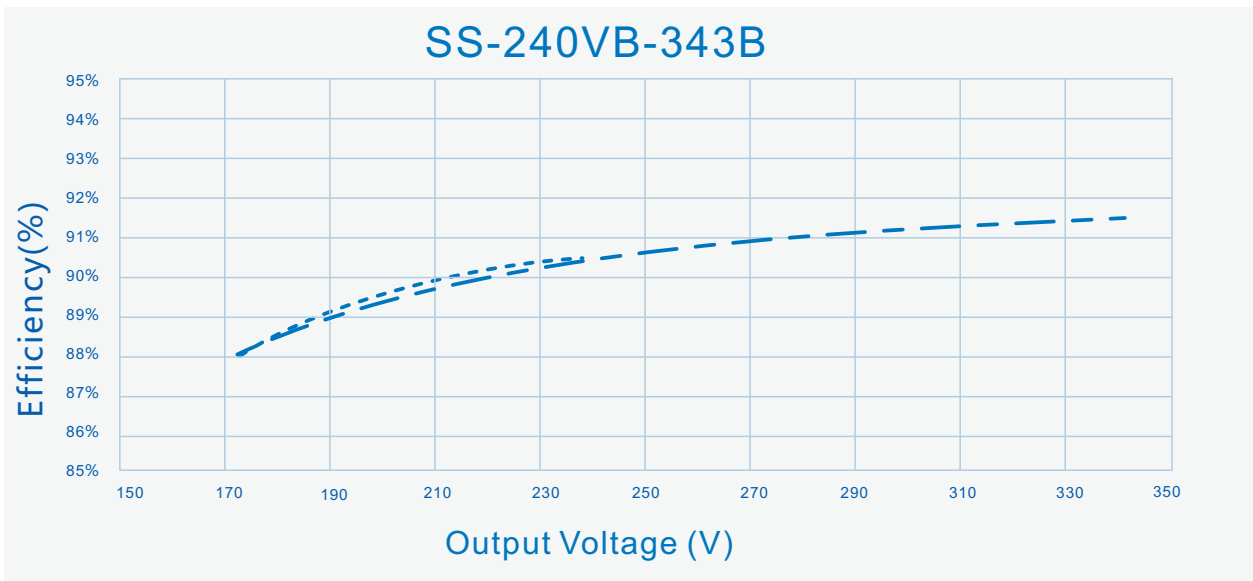

-----  $I_o=1050mA$

- . - . -  $I_o=700mA$





# SS-240VB Series LED Driver

## Performance Curves:

### Power Factor Vs. Output Power

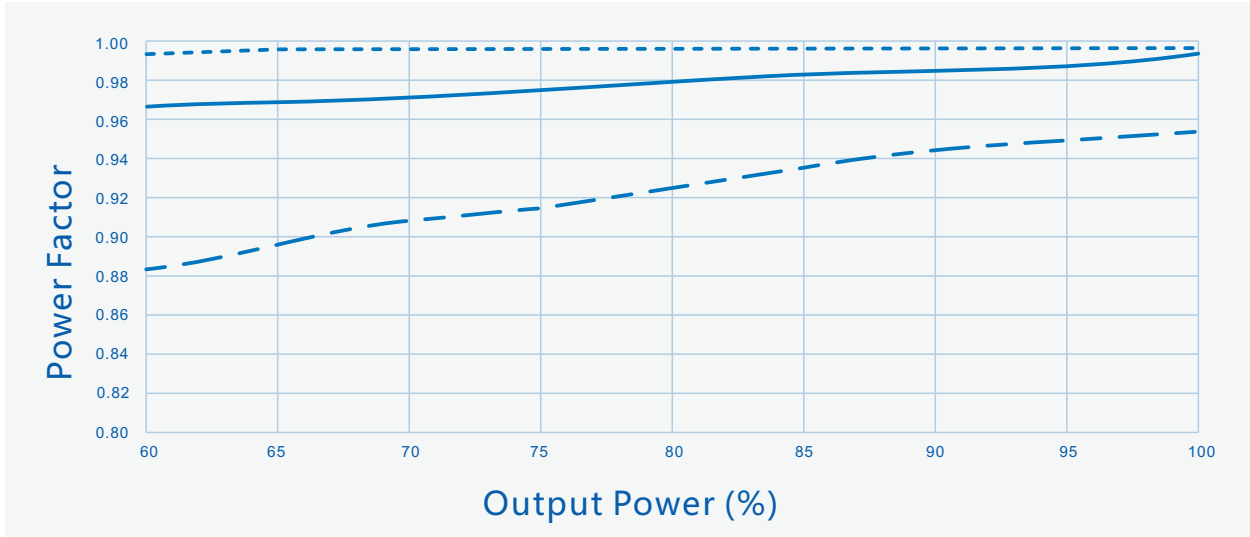

----- Vin=120Vac    ——— Vin=220Vac    - · - · Vin=277Vac

### THD Vs. Output Power

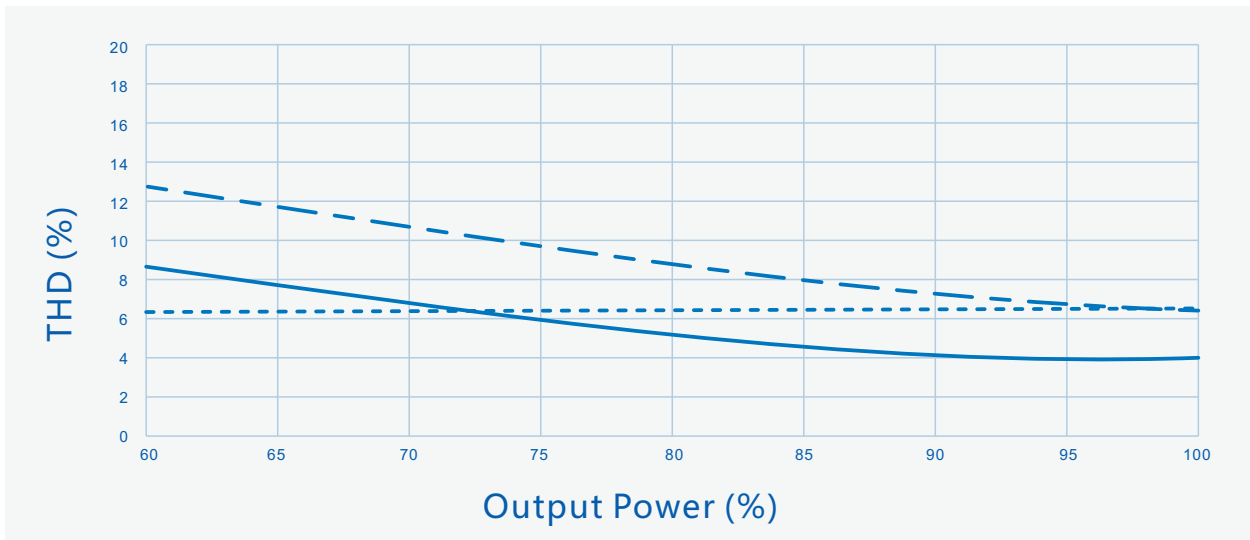

----- Vin=120Vac    ——— Vin=220Vac    - · - · Vin=277Vac

# SS-240VB Series LED Driver

## Performance Curves:

### Output power Vs. Input Voltage (Ta Max.50°C)

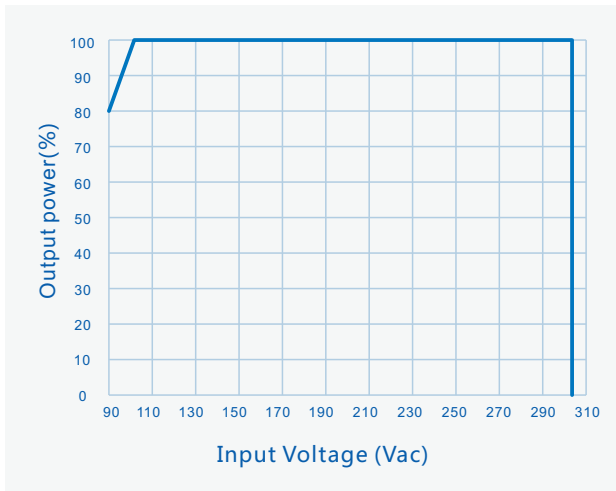

### Output power Vs. Case Temperature

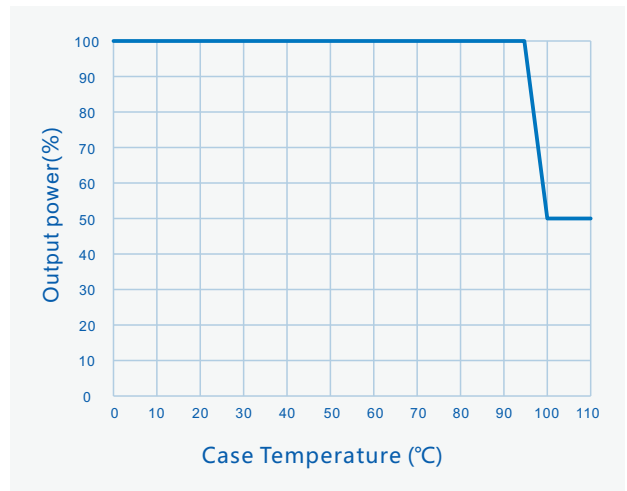

### Output Power Vs. Dimming

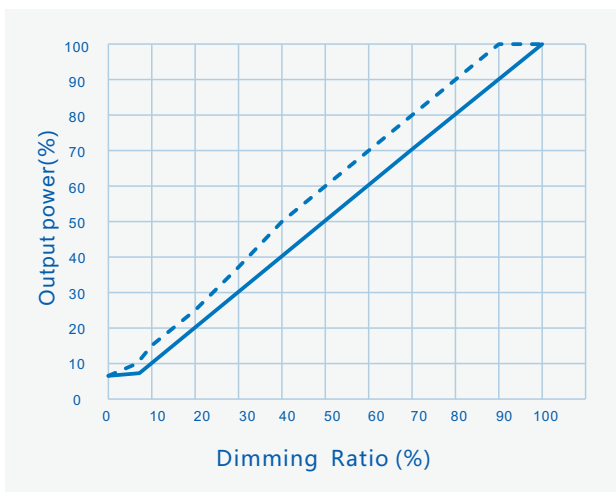

### Lifetime Vs. Case Temperature

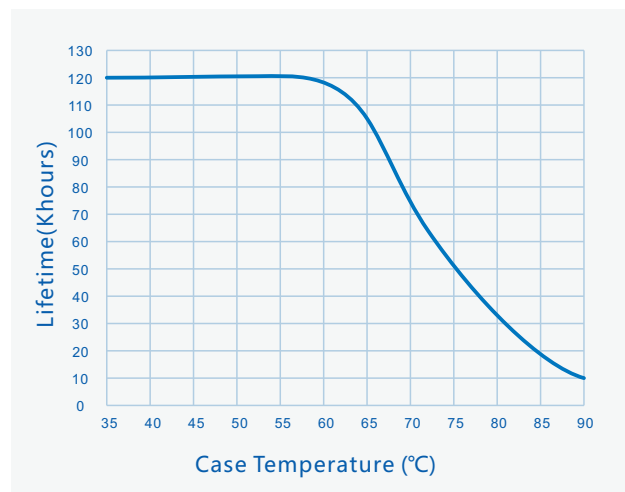

----- Resistance Dimming  
———— PWM/1-10V Dimming

# SS-240VB Series LED Driver

## Constant Lumen Output

Constant Lumen Output are design to maintain fixture's stable output lumen by increasing driver's output current within driver's life span to counteract LED lumen degradation.

## Programming connection diagram :

Legacy Timer: Driver's output follows the pre-programmed timing curve after turn-on.

Auto-Adjust by Percentage: Driver's output will be adjusted by automatically changed dimming curve by the period percentage based on the latest 5 dimming curve.

Auto-Adjust by Mid-point: Driver's output will be adjusted by automatically changed dimming curve by mid-point based on the latest 5 dimming curve.

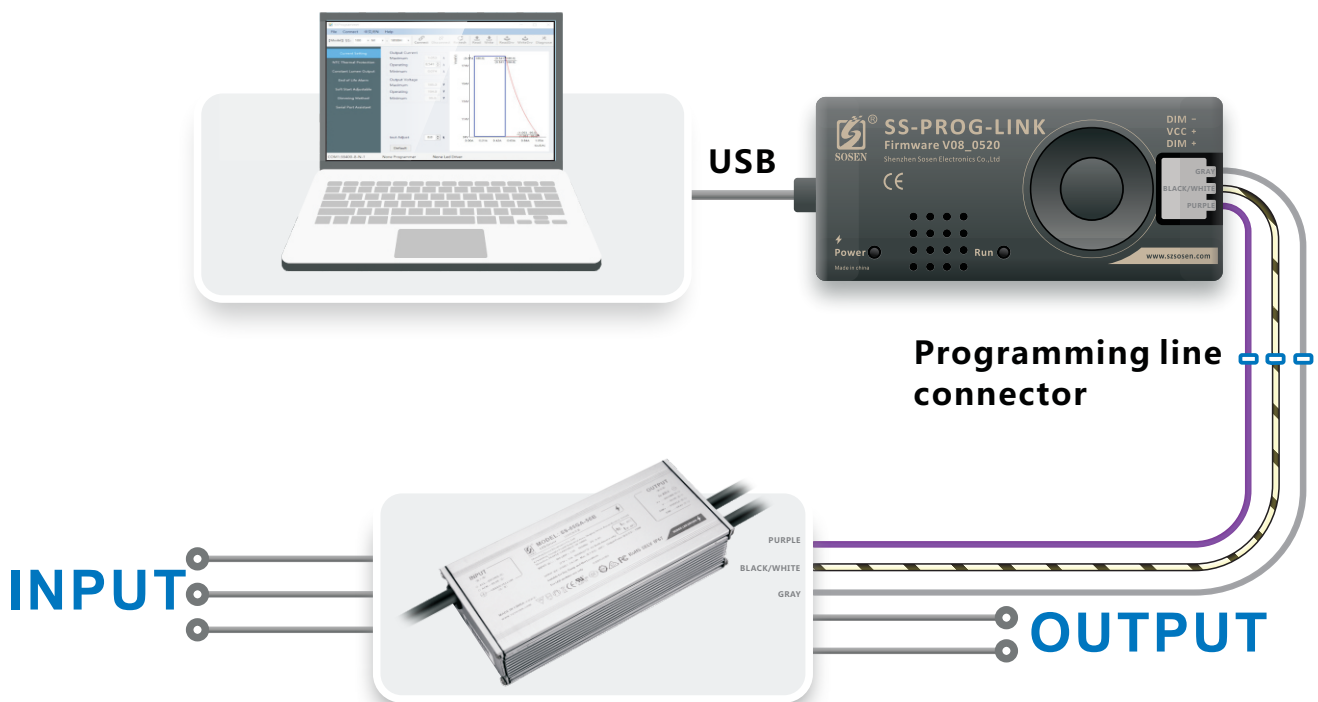

Note:

For details, please refer to the Sosen SS-PORG-LINK Programmer Manual.



# SS-240VB Series LED Driver

## Mechanical characteristics(Unit: mm)

**AC Input Cable**(Lead Length outside enclosure  $450\pm 10\text{mm}$ ):

UL model: SJTW,  $3\times 0.824\text{mm}^2$ , O.D: 7.8mm, Black:L, White:N, Green:PE  
Euro model: H05RN-F,  $3\times 1.0\text{mm}^2$ , O.D:7.4mm, Brown:L, Blue:N, Yellow/Green:PE

**DC Output Cable**(Lead Length outside enclosure  $250\pm 10\text{mm}$ ):

UL model: SJTW,  $2\times 0.824\text{mm}^2$ , O.D: 7.6mm, Red:LED+ , Black:LED-  
Euro model: H05RN-R,  $2\times 1.0\text{mm}^2$ , O.D:7.0mm, Brown:V+, Blue:V-

**DIM Cable**(Lead Length outside enclosure  $220\pm 10\text{mm}$ ):

UL/Euro model: STYLE 21996#22AWG, O.D: 4.9mm , Purple : DIM+, Gray: DIM-  
Black/White: VCC+

Name Description	Standard Code	mm(In.)
Case Length	L3	219(8.62)
Case Width	W1	71(2.8)
Case Height	H	39.6(1.56)
Overall Length	L1	244(9.61)
Mounting Hole Length	L2	229(9.02)
Mounting Hole Width	W2	34(1.34)
TC point position	X	117(4.61)
TC point position	Y	46(1.81)

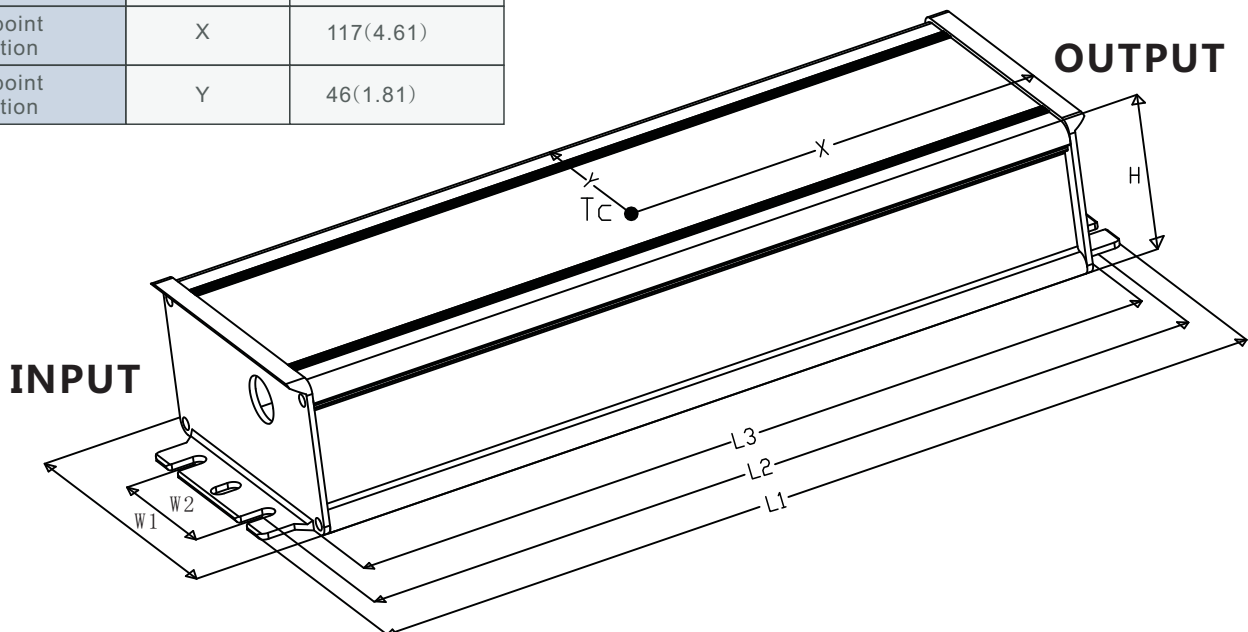

# SS-240VB Series LED Driver

---



## Installation Tips

1. Dimming leads should be capped if not in use to avoid dimming circuit damage caused by external signals.

## Package

- Outside carton dimension: L×W×H =500mm×390mm×170mm;
- 14PCS/Carton;
- Net weight/PC: 1.2kg;Gross weight/Carton: 17.8kg;
- Please refer to the product name, model number, manufacturer identification, quality inspection certificate, manufacturing date Etc. on the package. and LED power supply instruction manual in the package.

## Transportation

Packaging is designed suitable for transportation by trucks, vessels and flights. The products should be shielded from direct sunshine, loaded/unloaded with caution.

## Storage

The product storage meets the standard of the GB 3873 - 83.  
Products should be rechecked if stock for over 1 year before installation.

## RoHS

Products comply with European directive 2011/65/EC.

## REVISION HISTORY

Version	Description of Change	Changed Date	Remark
V00	Original release	2019/03/28	
V01	Update programming connection diagram	2019/07/13	

